



**Welding machines for MMA welding**

**Pico 300 cel**

**Pico 300 cel VRD**

**Pico 300 cel SVRD**

**Pico 300 cel pws**

**Pico 300 cel pws VRD**

**Pico 300 cel pws SVRD**

# General instructions

## CAUTION



### **Read the operating instructions!**

**The operating instructions provide an introduction to the safe use of the products.**

- Read the operating instructions for all system components!
- Observe accident prevention regulations!
- Observe all local regulations!
- Confirm with a signature where appropriate.

## NOTE



**In the event of queries on installation, commissioning, operation or special conditions at the installation site, or on usage, please contact your sales partner or our customer service department on +49 2680 181-0.**

**A list of authorised sales partners can be found at [www.ewm-group.com](http://www.ewm-group.com).**

Liability relating to the operation of this equipment is restricted solely to the function of the equipment. No other form of liability, regardless of type, shall be accepted. This exclusion of liability shall be deemed accepted by the user on commissioning the equipment.

The manufacturer is unable to monitor whether or not these instructions or the conditions and methods are observed during installation, operation, usage and maintenance of the equipment.

An incorrectly performed installation can result in material damage and injure persons as a result. For this reason, we do not accept any responsibility or liability for losses, damages or costs arising from incorrect installation, improper operation or incorrect usage and maintenance or any actions connected to this in any way.

# 1 Contents

<b>1</b>	<b>Contents</b> .....	<b>3</b>
<b>2</b>	<b>Safety instructions</b> .....	<b>5</b>
2.1	Notes on the use of these operating instructions .....	5
2.2	General .....	7
2.3	Transport and installation .....	10
2.4	Ambient conditions.....	11
2.4.1	In operation.....	11
2.4.2	Transport and storage .....	11
<b>3</b>	<b>Intended use</b> .....	<b>12</b>
3.1	Applications.....	12
3.1.1	MMA welding .....	12
3.1.2	TIG (Liftarc) welding .....	12
3.2	Overview of device types.....	12
3.2.1	Cellulose electrode types (cel) .....	12
3.2.2	Pole reversing switch (pws).....	12
3.2.3	Voltage reducing device (VRD/SVRD) .....	12
3.3	Documents which also apply .....	13
3.3.1	Warranty .....	13
3.3.2	Declaration of Conformity.....	13
3.3.3	Welding in environments with increased electrical hazards.....	13
3.3.4	Service documents (spare parts and circuit diagrams).....	13
<b>4</b>	<b>Machine description – quick overview</b> .....	<b>14</b>
4.1	Pico 300 cel .....	14
4.1.1	Front view .....	14
4.1.2	Rear view.....	16
4.2	Machine control – Operating elements .....	18
<b>5</b>	<b>Design and function</b> .....	<b>20</b>
5.1	General .....	20
5.2	Machine cooling .....	20
5.3	Workpiece lead, general .....	20
5.4	Transport and installation .....	21
5.4.1	Adjusting the length of the carrying strap.....	21
5.5	Mains connection.....	22
5.5.1	Mains configuration .....	22
5.6	MMA welding .....	23
5.6.1	Connecting the electrode holder and workpiece lead .....	23
5.6.1.1	Pico 300 cel.....	23
5.6.1.2	Pico 300 cel pws .....	24
5.6.2	Selecting MMA welding .....	26
5.6.2.1	Arcforce (welding characteristics) .....	26
5.6.3	Hotstart current and Hotstart time .....	27
5.6.4	Antistick .....	28
5.6.5	Advanced settings .....	28
5.6.5.1	Arcforce correction (welding characteristics) .....	28
5.7	TIG welding.....	29
5.7.1	Shielding gas supply (shielding gas cylinder for welding machine) .....	29
5.7.1.1	Connecting the shielding gas supply .....	30
5.7.2	Connecting a TIG welding torch with rotating gas valve .....	31
5.7.2.1	Pico 300 cel.....	31
5.7.2.2	Pico 300 cel pws .....	32
5.7.3	TIG welding selection .....	33
5.7.4	TIG arc ignition .....	33
5.7.4.1	Liftarc ignition .....	33

5.8	Advanced settings	34
5.8.1	Arc length restriction (USP)	34
5.8.2	Activating the welding current actual value display	35
5.9	Voltage reducing device (VRD/SVRD)	36
5.10	Remote control	36
5.10.1	Foot-operated remote control RTF 1	36
5.10.2	Manual remote control RT 1	36
5.10.3	Manual remote control RT PWS 1	36
5.11	Dirt filter	37
<b>6</b>	<b>Maintenance, care and disposal</b>	<b>38</b>
6.1	General	38
6.2	Maintenance work, intervals	38
6.2.1	Daily maintenance tasks	38
6.2.2	Monthly maintenance tasks	38
6.2.3	Annual test (inspection and testing during operation)	38
6.3	Repair Work	39
6.4	Disposing of equipment	39
6.4.1	Manufacturer's declaration to the end user	39
6.5	Meeting the requirements of RoHS	39
<b>7</b>	<b>Rectifying faults</b>	<b>40</b>
7.1	Error messages (power source)	40
7.2	Resetting welding parameters to the factory settings	41
<b>8</b>	<b>Technical data</b>	<b>42</b>
8.1	Pico 300 cel	42
<b>9</b>	<b>Accessories, options</b>	<b>43</b>
9.1	Welding torch, electrode holder and workpiece lead	43
9.2	Remote controls and accessories	43
9.2.1	Pico 300 cel pws	43
9.3	Options	43
9.4	General accessories	43
<b>10</b>	<b>Appendix A</b>	<b>44</b>
10.1	Overview of EWM branches	44

## 2 Safety instructions

### 2.1 Notes on the use of these operating instructions

#### DANGER

**Working or operating procedures which must be closely observed to prevent imminent serious and even fatal injuries.**

- Safety notes include the "DANGER" keyword in the heading with a general warning symbol.
- The hazard is also highlighted using a symbol on the edge of the page.

#### WARNING

**Working or operating procedures which must be closely observed to prevent serious and even fatal injuries.**

- Safety notes include the "WARNING" keyword in the heading with a general warning symbol.
- The hazard is also highlighted using a symbol in the page margin.

#### CAUTION

**Working or operating procedures which must be closely observed to prevent possible minor personal injury.**

- The safety information includes the "CAUTION" keyword in its heading with a general warning symbol.
- The risk is explained using a symbol on the edge of the page.

#### CAUTION

**Working and operating procedures which must be followed precisely to avoid damaging or destroying the product.**

- The safety information includes the "CAUTION" keyword in its heading without a general warning symbol.
- The hazard is explained using a symbol at the edge of the page.













#### NOTE

**Special technical points which users must observe.**

- Notes include the "NOTE" keyword in the heading without a general warning symbol.

Instructions and lists detailing step-by-step actions for given situations can be recognised via bullet points, e.g.:

- Insert the welding current lead socket into the relevant socket and lock.

Symbol	Description
	Press
	Do not press
	Turn
	Switch
	Switch off machine
	Switch on machine
	ENTER (enter the menu)
	NAVIGATION (Navigating in the menu)
	EXIT (Exit the menu)
	Time display (example: wait 4s/press)
	Interruption in the menu display (other setting options possible)
	Tool not required/do not use
	Tool required/use

## 2.2 General

### DANGER



#### **Electromagnetic fields!**

The power source may cause electrical or electromagnetic fields to be produced which could affect the correct functioning of electronic equipment such as IT or CNC devices, telecommunication lines, power cables, signal lines and pacemakers.

- Observe the maintenance instructions! (see Maintenance and Testing chapter)
- Unwind welding lines completely!
- Shield devices or equipment sensitive to radiation accordingly!
- The correct functioning of pacemakers may be affected (obtain advice from a doctor if necessary).



#### **Do not carry out any unauthorised repairs or modifications!**

To avoid injury and equipment damage, the unit must only be repaired or modified by specialist, skilled persons!

The warranty becomes null and void in the event of unauthorised interference.

- Appoint only skilled persons for repair work (trained service personnel)!



#### **Electric shock!**

Welding machines use high voltages which can result in potentially fatal electric shocks and burns on contact. Even low voltages can cause you to get a shock and lead to accidents.

- Do not touch any live parts in or on the machine!
- Connection cables and leads must be free of faults!
- Switching off alone is not sufficient!
- Place welding torch and stick electrode holder on an insulated surface!
- The unit should only be opened by specialist staff after the mains plug has been unplugged!
- Only wear dry protective clothing!
- Wait for 4 minutes until the capacitors have discharged!

### WARNING



#### **Risk of injury due to radiation or heat!**

Arc radiation results in injury to skin and eyes.

Contact with hot workpieces and sparks results in burns.

- Wear dry protective clothing (e.g. welding shield, gloves, etc.) according to the relevant regulations in the country in question!
- Protect persons not involved in the work against arc beams and the risk of glare using safety curtains!



#### **Explosion risk!**

Apparently harmless substances in closed containers may generate excessive pressure when heated.

- Move containers with inflammable or explosive liquids away from the working area!
- Never heat explosive liquids, dusts or gases by welding or cutting!

## WARNING



### Smoke and gases!

Smoke and gases can lead to breathing difficulties and poisoning. In addition, solvent vapour (chlorinated hydrocarbon) may be converted into poisonous phosgene due to the ultraviolet radiation of the arc!

- Ensure that there is sufficient fresh air!
- Keep solvent vapour away from the arc beam field!
- Wear suitable breathing apparatus if appropriate!



### Fire hazard!

Flames may arise as a result of the high temperatures, stray sparks, glowing-hot parts and hot slag produced during the welding process.

Stray welding currents can also result in flames forming!

- Check for fire hazards in the working area!
- Do not carry any easily flammable objects such as matches or lighters.
- Keep appropriate fire extinguishing equipment to hand in the working area!
- Thoroughly remove any residue of flammable substances from the workpiece before starting welding.
- Only continue work on welded workpieces once they have cooled down.  
Do not allow to come into contact with flammable material!
- Connect welding leads correctly!



### Risk of accidents if these safety instructions are not observed!

Non-observance of these safety instructions is potentially fatal!

- Carefully read the safety information in this manual!
- Observe the accident prevention regulations in your country.
- Inform persons in the working area that they must observe the regulations!

## CAUTION



### Noise exposure!

Noise exceeding 70 dBA can cause permanent hearing damage!

- Wear suitable ear protection!
- Persons located within the working area must wear suitable ear protection!



**CAUTION****Obligations of the operator!**

**The respective national directives and laws must be observed for operation of the machine!**

- National implementation of the framework directive (89/391/EEG), as well as the associated individual directives.
- In particular, directive (89/655/EEG), on the minimum regulations for safety and health protection when staff members use equipment during work.
- The regulations regarding work safety and accident prevention for the respective country.
- Setting up and operating the machine according to IEC 60974-9.
- Check at regular intervals that users are working in a safety-conscious way.
- Regular checks of the machine according to IEC 60974-4.

**Damage due to the use of non-genuine parts!**

**The manufacturer's warranty becomes void if non-genuine parts are used!**

- Only use system components and options (power sources, welding torches, electrode holders, remote controls, spare parts and replacement parts, etc.) from our range of products!
- Only insert and lock accessory components into the relevant connection socket when the machine is switched off.

**Electromagnetic interference!**

**The machines are intended to be used in industrial areas, according to IEC 60974-10. If they are used in residential areas, for example, problems may occur with ensuring electromagnetic compatibility.**

- Check whether interference is caused to other machines!

## 2.3 Transport and installation

### WARNING



#### **Incorrect handling of shielding gas cylinders!**

**Incorrect handling of shielding gas cylinders can result in serious and even fatal injury.**

- Observe the instructions from the gas manufacturer and in any relevant regulations concerning the use of compressed air!
- Place shielding gas cylinders in the holders provided for them and secure with fixing devices.
- Avoid heating the shielding gas cylinder!

### CAUTION



#### **Risk of tipping!**

**There is a risk of the machine tipping over and injuring persons or being damaged itself during movement and set up. Tilt resistance is guaranteed up to an angle of 10° (according to IEC 60974-1, -3, -10).**

- Set up and transport the machine on level, solid ground.
- Secure add-on parts using suitable equipment.



#### **Damage due to supply lines not being disconnected!**

**During transport, supply lines which have not been disconnected (mains supply leads, control leads, etc.) may cause hazards such as connected equipment tipping over and injuring persons!**

- Disconnect supply lines!

### CAUTION



#### **Equipment damage when not operated in an upright position!**

**The units are designed for operation in an upright position!**

**Operation in non-permissible positions can cause equipment damage.**

- Only transport and operate in an upright position!

## 2.4 Ambient conditions

### CAUTION



#### Installation site!

**The machine must not be operated in the open air and must only be set up and operated on a suitable, stable and level base!**

- The operator must ensure that the ground is non-slip and level, and provide sufficient lighting for the place of work.
- Safe operation of the machine must be guaranteed at all times.

### CAUTION



#### Equipment damage due to dirt accumulation!

**Unusually high quantities of dust, acid, corrosive gases or substances may damage the equipment.**

- Avoid high volumes of smoke, vapour, oil vapour and grinding dust!
- Avoid ambient air containing salt (sea air)!



#### Non-permissible ambient conditions!

**Insufficient ventilation results in a reduction in performance and equipment damage.**

- Observe the ambient conditions!
- Keep the cooling air inlet and outlet clear!
- Observe the minimum distance of 0.5 m from obstacles!

### 2.4.1 In operation

**Temperature range of the ambient air:**

- -20 °C to +40 °C

**Relative air humidity:**

- Up to 50% at 40 °C
- Up to 90% at 20 °C

### 2.4.2 Transport and storage

**Storage in an enclosed space, temperature range of the ambient air:**

- -25 °C to +55 °C

**Relative air humidity**

- Up to 90% at 20 °C

## 3 Intended use

This machine has been manufactured according to the latest developments in technology and current regulations and standards. It must only be operated in line with the instructions on correct usage.



### WARNING



**Hazards due to improper usage!**

**Hazards may arise for persons, animals and material objects if the equipment is not used correctly. No liability is accepted for any damages arising from improper usage!**

- The equipment must only be used in line with proper usage and by trained or expert staff!
- Do not modify or convert the equipment improperly!

### 3.1 Applications

#### 3.1.1 MMA welding

Manual arc welding or, for short, MMA welding. It is characterised by the fact that the arc burns between a melting electrode and the molten pool. There is no external protection; any protection against the atmosphere comes from the electrode.

#### 3.1.2 TIG (Liftarc) welding

TIG welding process with arc ignition by means of workpiece contact.

### 3.2 Overview of device types

#### 3.2.1 Cellulose electrode types (cel)

CEL device types are equipped with special Arcforce characteristics.

These device types facilitate welding with cellulose electrode types which is safe for vertical-down welding, especially in the lower output range.

#### 3.2.2 Pole reversing switch (pws)

With PWS device types, the polarity of the welding current connections (pole reversal) can be changed using a changeover switch on the machine or on the remote control.

Useful function with frequently changing electrode types without time-consuming reconnection of the welding current connections (also directly at the operating point, in combination with a PWS remote control).

#### 3.2.3 Voltage reducing device (VRD/SVRD)

The voltage reducing device is a requirement in some countries and in many internal company safety guidelines for power sources.

A distinction is made between two versions:

- VRD (**V**oltage **R**eduction **D**evice) or
- SVRD (**S**low **V**oltage **R**eduction **D**evice)

Both switches meet the European standard (EN 60974-1:2005) and result in an increase in safety in hazardous environments in particular (such as ship construction, pipe construction, mining).

VRD reduces the open circuit voltage to 12 V within 0.2 s and thus fulfils the Australian standard (AS 1674.2-2003). SVRD reduces the open circuit voltage within 0.8 s to 12 V and thus fulfils the Russian standard (ГОСТ 12.2 007.8).

### 3.3 Documents which also apply

#### 3.3.1 Warranty

##### NOTE



For further information, please see the accompanying supplementary sheets "Machine and Company Data, Maintenance and Testing, Warranty"!

#### 3.3.2 Declaration of Conformity



The designated machine conforms to EC Directives and standards in terms of its design and construction:

- EC Low Voltage Directive (2006/95/EC),
- EC EMC Directive (2004/108/EC),

This declaration shall become null and void in the event of unauthorised modifications, improperly conducted repairs, non-observance of the deadlines for the repetition test and / or non-permitted conversion work not specifically authorised by the manufacturer.

The original copy of the declaration of conformity is enclosed with the unit.

#### 3.3.3 Welding in environments with increased electrical hazards



In compliance with IEC / DIN EN 60974, VDE 0544 the machines can be used in environments with an increased electrical hazard.

#### 3.3.4 Service documents (spare parts and circuit diagrams)



##### DANGER



**Do not carry out any unauthorised repairs or modifications!**

**To avoid injury and equipment damage, the unit must only be repaired or modified by specialist, skilled persons!**

**The warranty becomes null and void in the event of unauthorised interference.**

- Appoint only skilled persons for repair work (trained service personnel)!

Original copies of the circuit diagrams are enclosed with the unit.

Spare parts can be obtained from the relevant authorised dealer.

## 4 Machine description – quick overview

### 4.1 Pico 300 cel

#### 4.1.1 Front view

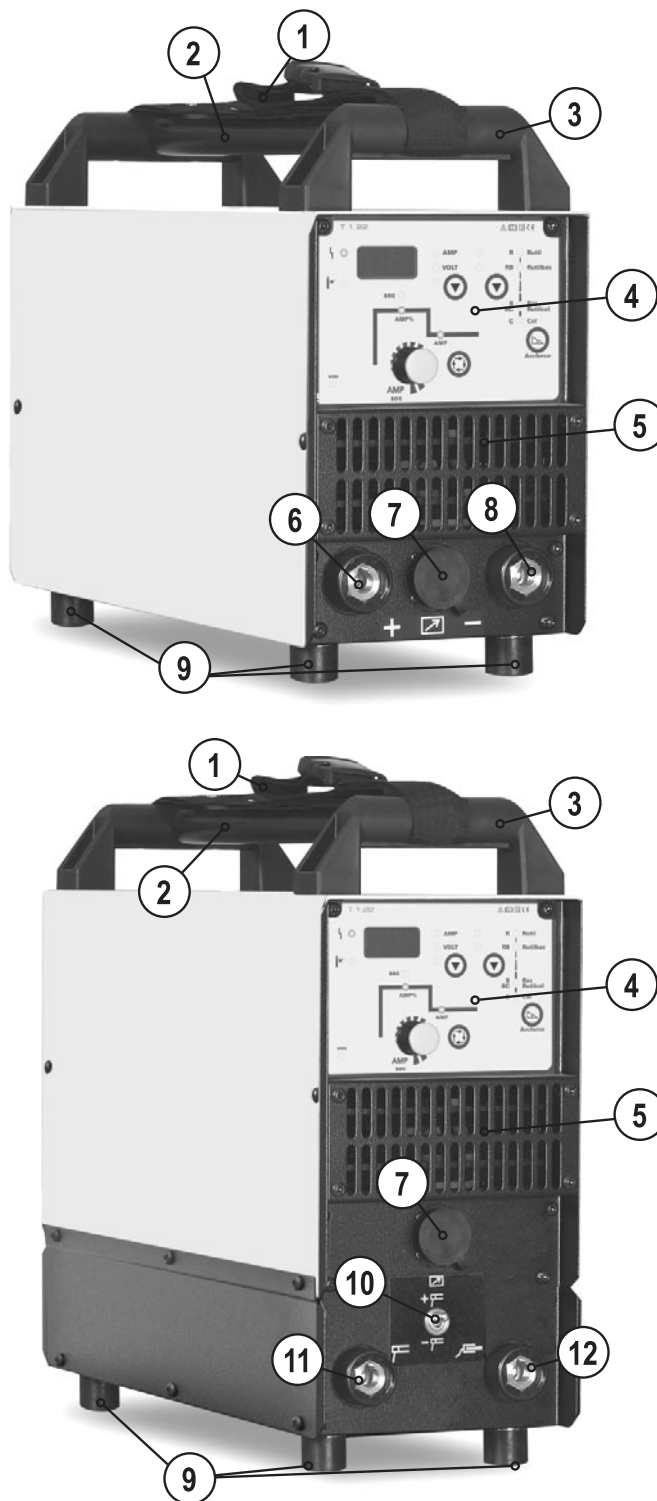







Figure 4-1

Item	Symbol	Description
1		<b>Carrying strap</b>
2		<b>Transport bar</b>
3		<b>Carrying handle</b>
4		<b>Machine control</b> See Machine control – operating elements chapter
5		<b>Cooling air inlet</b>
6		<b>Connection socket, "+" welding current</b> <ul style="list-style-type: none"> <li>• TIG: Connection for workpiece lead</li> <li>• MMA: Electrode holder or workpiece lead connection</li> </ul>
7		<b>Connection socket, 19-pole</b> Remote control connection
8		<b>Connection socket, "-" welding current</b> Electrode holder or workpiece lead connection
9		<b>Machine feet</b>
10	 <p> <math>+ \text{FF}</math> = Welding current polarity "+" on connection socket <math>\text{FF}</math>.  <math>- \text{FF}</math> = Welding current polarity "-" on connection socket <math>\text{FF}</math>.         </p>	<b>Pole reversal changeover switch</b> The changeover switch is used to switch over the welding current polarity ("+" or "-") of the electrode holder and workpiece lead connection sockets.
11		<b>Connection socket, electrode holder</b> The welding current polarity ("+" or "-") are based on the setting of the "Welding current polarity changeover switch".
12		<b>Connection socket, workpiece lead</b> The welding current polarity ("+" or "-") are based on the setting of the "Welding current polarity changeover switch".

## 4.1.2 Rear view

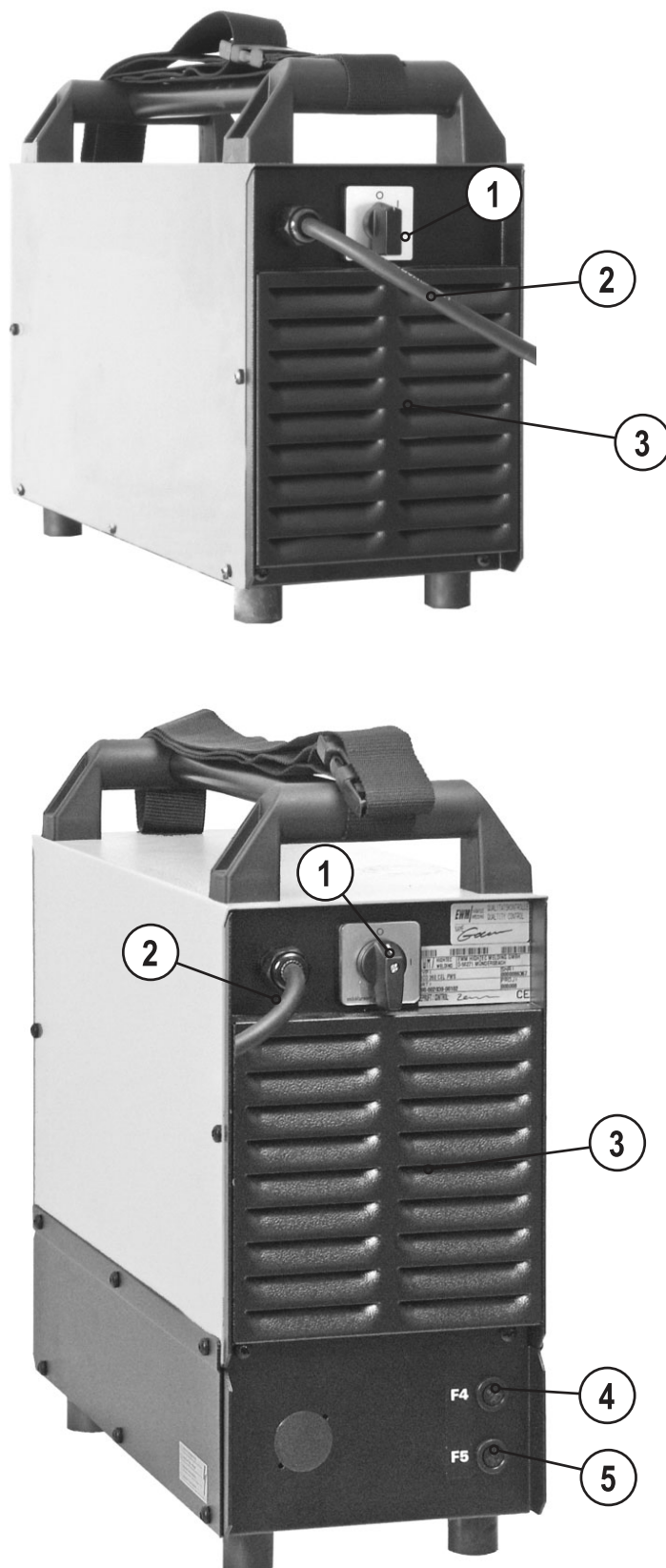



Figure 4-2



Item	Symbol	Description
1		<b>Main switch, machine on/off</b>
2		<b>Mains connection cable</b>
3		<b>Cooling air outlet</b>
4	<b>F4</b>	<b>Fuse</b> Solenoid switch pole reversal fuse
5	<b>F5</b>	<b>Fuse</b> Solenoid switch pole reversal fuse

## 4.2 Machine control – Operating elements

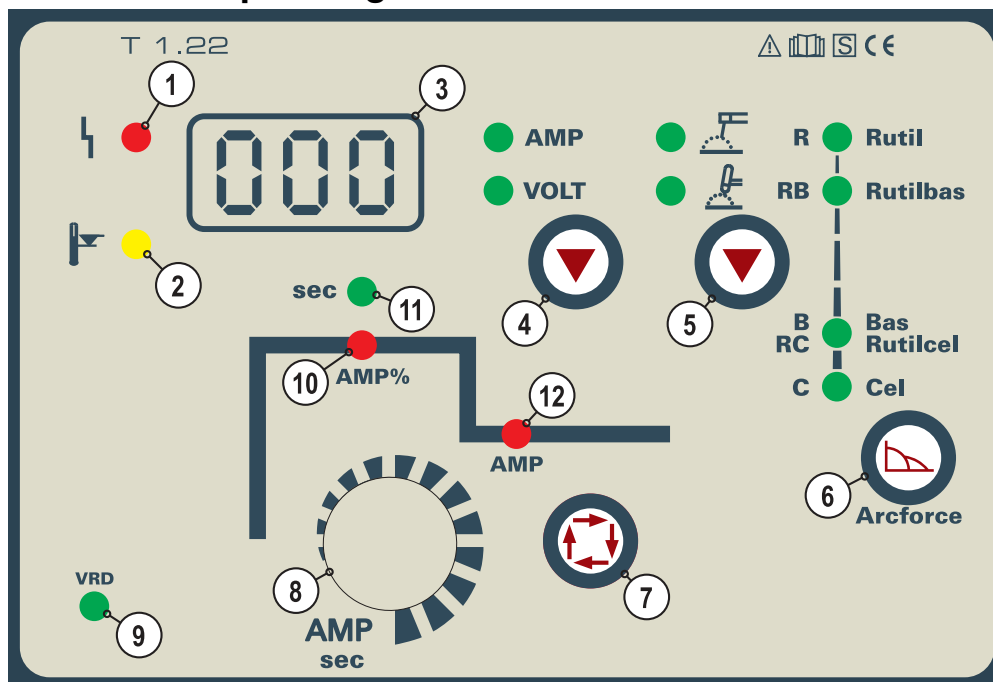











Figure 4-3

Item	Symbol	Description
1		<b>Collective interference signal light</b> For error messages, see the "Rectifying faults" chapter
2		<b>Excess temperature signal light</b> In case of excess temperature, temperature monitors de-activate the power unit, and the excess temperature control lamp comes on. Once the machine has cooled down, welding can continue without any further measures.
3		<b>Three-figure LED display</b> Display of welding current and voltage, welding parameters, error code
4		<b>Switch display button</b> AMP     Welding current display VOLT    Welding voltage display
5		<b>Welding process button</b>  MMA welding  TIG welding
6		<b>"Arcforce" button (welding characteristics) according to electrode type</b>
7		<b>Select welding parameters button</b> This button is used to select the welding parameters depending on the welding process and operating mode used.
8		<b>Welding parameter setting rotary transducer</b> Setting of welding current and other welding parameter and their values
9	<b>VRD</b>	<b>VRD open circuit voltage reduction</b>
10	<b>AMP%</b>	<b>Hotstart current signal light</b> 50 % to 200 % of the main current
11	<b>sec</b>	<b>Hotstart time signal light (0.1 s to 20 s)</b>
12	<b>AMP</b>	<b>Main current signal light</b>

## 5 Design and function

### 5.1 General



#### DANGER



#### Risk of injury from electric shock!

#### Contact with live parts, e.g. welding current sockets, is potentially fatal!

- Follow safety instructions on the opening pages of the operating instructions.
- Commissioning may only be carried out by persons who have the relevant expertise of working with arc welding machines!
- Connection and welding leads (e.g. electrode holder, welding torch, workpiece lead, interfaces) may only be connected when the machine is switched off!



#### CAUTION



#### Risk of burns on the welding current connection!

#### If the welding current connections are not locked, connections and leads heat up and can cause burns, if touched!

- Check the welding current connections every day and lock by turning in clockwise direction, if necessary.

#### CAUTION



#### Using protective dust caps!

#### Protective dust caps protect the connection sockets and therefore the machine against dirt and damage.

- The protective dust cap must be fitted if there is no accessory component being operated on that connection.
- The cap must be replaced if faulty or if lost!

### 5.2 Machine cooling

To obtain an optimal duty cycle from the power components, the following precautions should be observed:

- Ensure that the working area is adequately ventilated.
- Do not obstruct the air inlets and outlets of the machine.
- Do not allow metal parts, dust or other objects to get into the machine.

### 5.3 Workpiece lead, general



#### CAUTION



#### Risk of burns due to incorrect connection of the workpiece lead!

#### Paint, rust and dirt on the connection restrict the power flow and may lead to stray welding currents.

#### Stray welding currents may cause fires and injuries!

- Clean the connections!
- Fix the workpiece lead securely!
- Do not use structural parts of the workpiece as a return lead for the welding current!
- Take care to ensure faultless power connections!

## 5.4 Transport and installation

### ⚠ CAUTION



#### Installation site!

The machine must not be operated in the open air and must only be set up and operated on a suitable, stable and level base!

- The operator must ensure that the ground is non-slip and level, and provide sufficient lighting for the place of work.
- Safe operation of the machine must be guaranteed at all times.

### 5.4.1 Adjusting the length of the carrying strap

#### NOTE



To demonstrate adjustment, lengthening the strap is shown in the figure. To shorten, the strap's loops must be inched in the opposite direction.

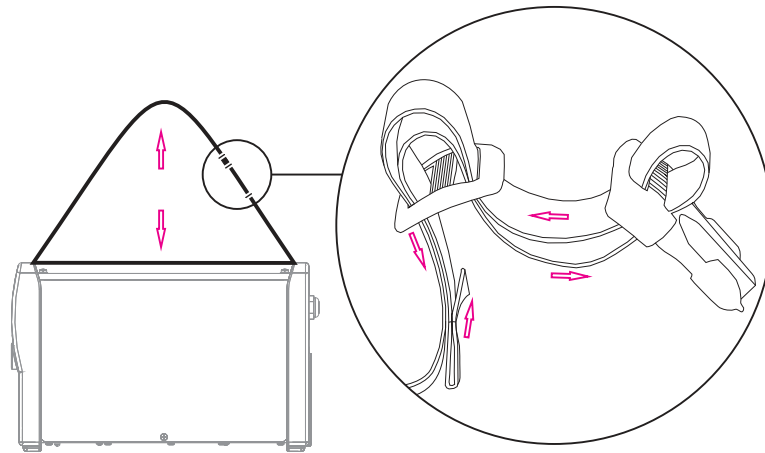

Figure 5-1

## 5.5 Mains connection

### ⚠ DANGER



**Hazard caused by improper mains connection!**

**An improper mains connection can cause injuries or damage property!**

- Only use machine with a plug socket that has a correctly fitted protective conductor.
- If a mains plug must be fitted, this may only be carried out by an electrician in accordance with the relevant national provisions or regulations (any phase sequence for three-phase machines)!
- Mains plug, socket and lead must be checked regularly by an electrician!

### 5.5.1 Mains configuration

#### NOTE



The machine may be connected to TN, TT or IT networks with a protective conductor (as available).

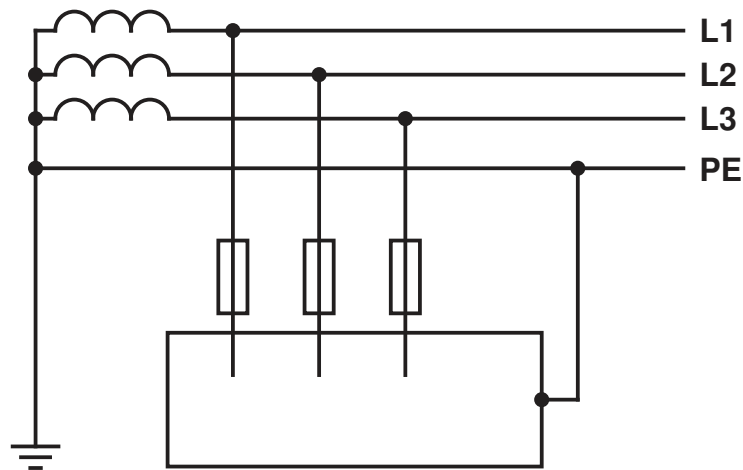

Figure 5-2

**Legend**

Item	Designation	Colour code
L1	Outer conductor 1	black
L2	Outer conductor 2	brown
L3	Outer conductor 3	grey
PE	Protective conductor	green-yellow

### CAUTION



**Operating voltage - mains voltage!**

**The operating voltage shown on the rating plate must be consistent with the mains voltage, in order to avoid damage to the machine!**

- For mains fuse protection, please refer to the “Technical data” chapter!

- Insert mains plug of the switched-off machine into the appropriate socket.

## 5.6 MMA welding

### CAUTION



**Risk of being crushed or burnt.**

**When replacing spent or new stick electrodes**

- Switch off machine at the main switch
- Wear appropriate safety gloves
- Use insulated tongs to remove spent stick electrodes or to move welded workpieces and
- Always put the electrode holder down on an insulated surface.

### NOTE



**Polarity depends on the instructions from the electrode manufacturer given on the electrode packaging.**

### 5.6.1 Connecting the electrode holder and workpiece lead

#### 5.6.1.1 Pico 300 cel

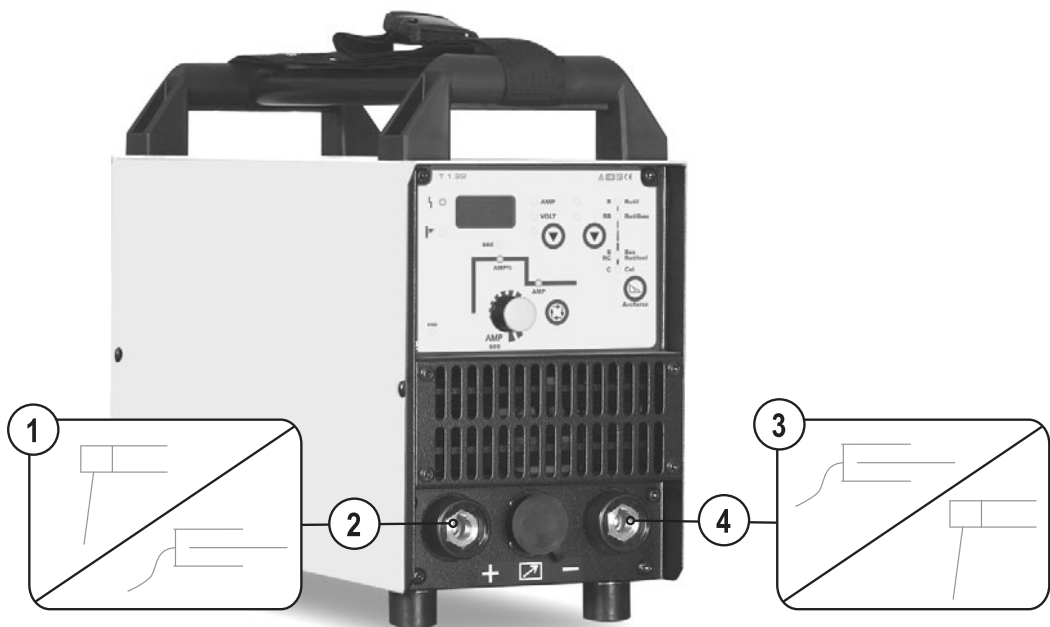

Figure 5-3

Item	Symbol	Description
1		<b>Electrode holder</b>
2	+	<b>Connection socket for "+" welding current</b> Electrode holder or workpiece lead connection
3		<b>Workpiece</b>
4	-	<b>Connection socket, "-" welding current</b> Workpiece lead or electrode holder connection

- Insert cable plug of the electrode holder into either the "+" or "-" welding current connection socket and lock by turning to the right.
- Insert cable plug of the workpiece lead into either the "+" or "-" welding current connection socket and lock by turning to the right.

## 5.6.1.2 Pico 300 cel pws

### NOTE

+ / - The pole reversal changeover switch allows the welding current polarity (+/-) to be changed without unplugging the electrode holder or workpiece leads. Changeover can also be carried out using a suitable remote control (PWS). The polarity cannot be changed during welding!

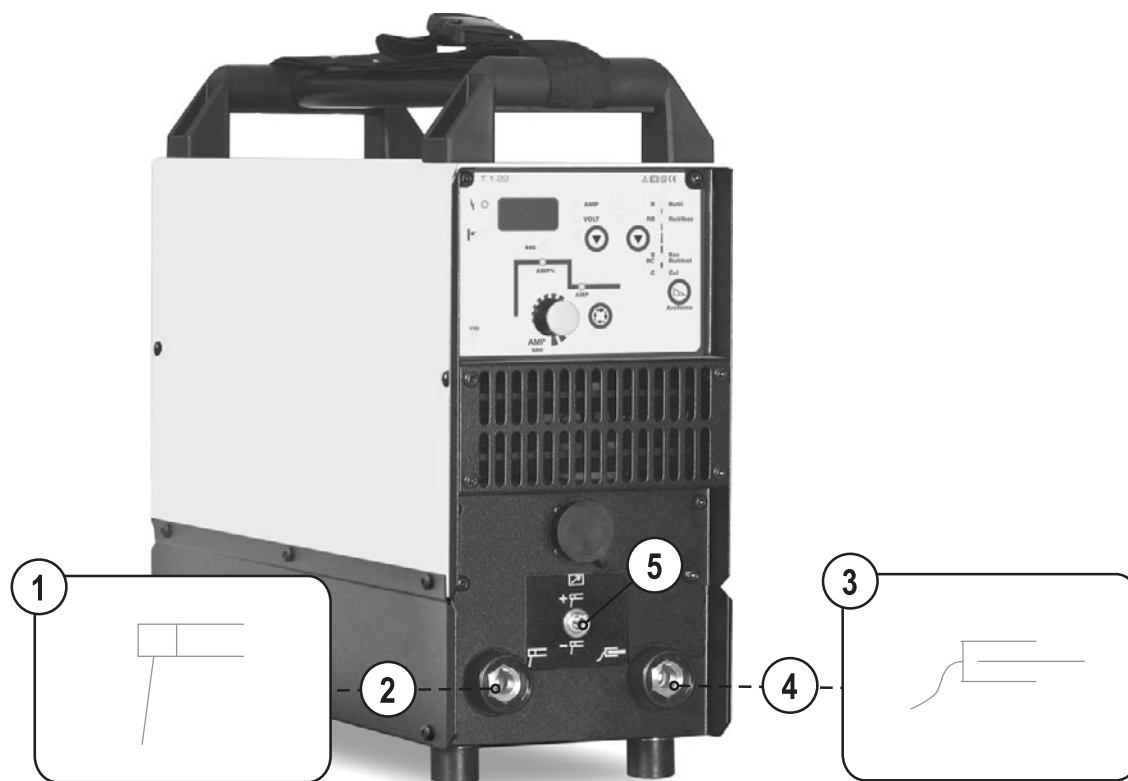











Figure 5-4



Item	Symbol	Description
1		<b>Electrode holder</b>
2		<b>Connection socket, electrode holder</b> The welding current polarity (“+” or “-”) are based on the setting of the “Welding current polarity changeover switch”.
3		<b>Workpiece</b>
4		<b>Connection socket, workpiece lead</b> The welding current polarity (“+” or “-”) are based on the setting of the “Welding current polarity changeover switch”.
5		<b>Pole reversal changeover switch</b> The changeover switch is used to switch over the welding current polarity (“+” or “-”) of the electrode holder and workpiece lead connection sockets. +  = Welding current polarity “+” on connection socket  . -  = Welding current polarity “-” on connection socket  .

- Insert cable plug on the electrode holder into the welding current socket “” and lock by turning to the right.
- Insert cable plug on the workpiece lead into the welding current socket “” and lock by turning to the right.

## 5.6.2 Selecting MMA welding

Operating element	Action	Result
		<b>Select MMA welding process</b> The  signal light lights up in green
		<b>Set welding current</b>

### 5.6.2.1 Arcforce (welding characteristics)

During the welding process, arcforce prevents the electrode sticking in the weld pool with increases in current. This makes it easier to weld large-drop melting electrode types at low current strengths with a short arc in particular.

#### NOTE

The selectable electrode characteristics on the machine control are guideline values. Every characteristic can also be optimised for the relevant electrode types and their welding properties (see chapter "Arcforce correction").

The electrode types used must be selected on the machine control to achieve the optimum welding properties of the electrode types.

Control element	Action	Result
<p>Arcforce</p>	<p>x x</p>	The corresponding signal light displays the selection.

#### Electrode type allocation

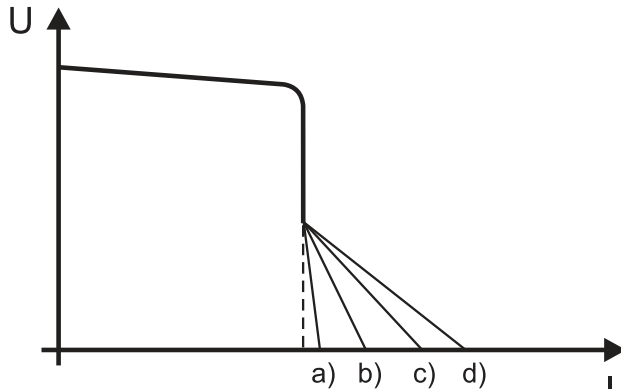

Item	Electrode type	
a)	R  Rutil	rutile
b)	RB  Rutilbas	rutile basic
c)	B RC  Bas Rutilcel	basic and rutile/cellulose
d)	C  Cel	cellulose

Figure 5-5

## 5.6.3 Hotstart current and Hotstart time

The hotstart device uses an increased ignition current to improve arc ignition. The parameters for the hotstart current and time can be adjusted individually.

When the stick electrode has been struck, the arc ignites at the adjusted hotstart current AMP% (factory setting: 120 % of main current) and welds at this current until the hotstart time in seconds has elapsed (factory setting: 1 second). The hotstart current then reduces to the main current set.

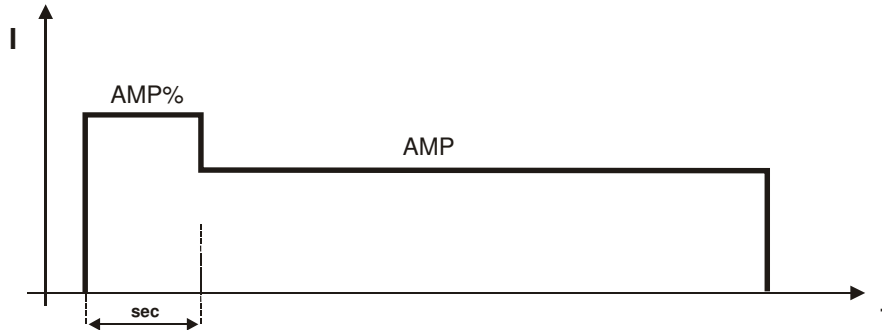

Symbol	Meaning
AMP	Main current
AMP%	Hotstart current
sec	Hotstart time

Figure 5-6

### Hotstart current

Control element	Action	Result
	n x	Signal light AMP% lights up
		Hotstart current is set as a percentage of the main current (50 % to 200 %)

### Hotstart time

Control element	Action	Result
	n x	Signal light sec lights up
		Hotstart time is set (0.1 s to 20 s)

### NOTE



After a waiting time of approx 5 s, the display changes back to the main current set and the signal light AMP comes on.

## 5.6.4 Antistick

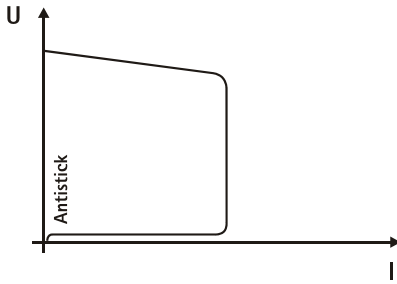

**Anti-stick prevents the electrode from annealing.**

If the electrode sticks in spite of the Arcforce device, the machine automatically switches over to the minimum current within about 1 second to prevent the electrode from overheating. Check the welding current setting and correct according to the welding task!

Figure 5-7

## 5.6.5 Advanced settings

### NOTE

To enable the greatest possible breadth of applications, the following parameters can be adjusted or optimised for the welding task.

### 5.6.5.1 Arcforce correction (welding characteristics)

### NOTE

To change the advanced setting parameters, hold down the "Welding parameters" button for 2 seconds after selecting the welding process.

The following diagram shows the setting options.

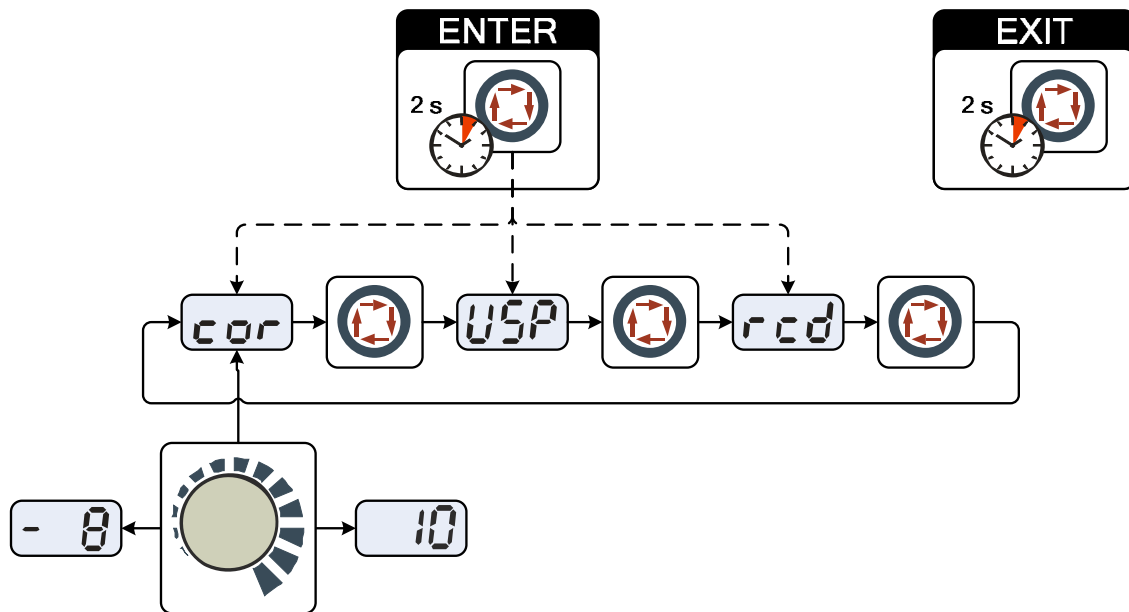

Figure 5-8

Display	Setting/selection
	<b>Arcforce correction (setting -8 to 10, factory setting 0)</b> <ul style="list-style-type: none"> <li>• Increase value &gt; harder arc</li> <li>• Decrease value &gt; softer arc</li> </ul>

### Example:

You are using a rutile/basic electrode type and set "RB Rutilbas" accordingly on the machine control. When welding the electrode type, you specify a hard or aggressive arc. You should now change the arcforce setting in the direction of "less arcforce – softer arc" until the required result is achieved.

## 5.7 TIG welding

### 5.7.1 Shielding gas supply (shielding gas cylinder for welding machine)

#### WARNING



##### **Incorrect handling of shielding gas cylinders!**

**Incorrect handling of shielding gas cylinders can result in serious and even fatal injury.**

- Observe the instructions from the gas manufacturer and in any relevant regulations concerning the use of compressed air!
- Place shielding gas cylinders in the holders provided for them and secure with fixing devices.
- Avoid heating the shielding gas cylinder!

#### CAUTION



##### **Faults in the shielding gas supply.**

**An unhindered shielding gas supply from the shielding gas cylinder to the welding torch is a fundamental requirement for optimum welding results. In addition, a blocked shielding gas supply may result in the welding torch being destroyed.**

- Always re-fit the yellow protective cap when not using the shielding gas connection.
- All shielding gas connections must be gas tight.

#### NOTE



**Before connecting the pressure reducer to the gas cylinder, open the cylinder valve briefly to expel any dirt.**

## 5.7.1.1 Connecting the shielding gas supply

- Secure the shielding gas cylinder using a securing chain.

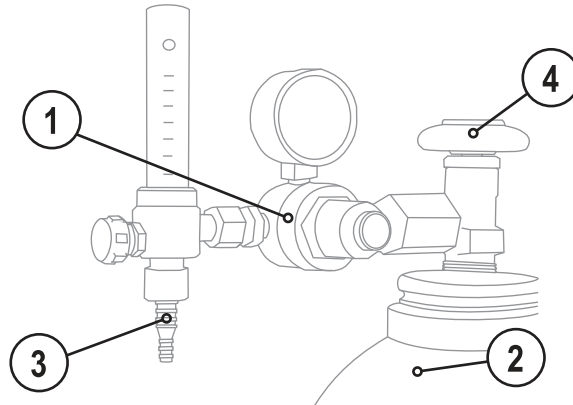

Figure 5-9

Item	Symbol	Description
1		Pressure reducer
2		Shielding gas cylinder
3		Output side of the pressure reducer
4		Cylinder valve

- Tighten the pressure reducer screw connection on the gas bottle valve to be gas-tight.
- Screw the shielding gas connection of the welding torch to the pressure reducer on the shielding gas cylinder.
- Slowly open the gas cylinder valve.
- Open the rotating valve on the welding torch

**Before each welding process, the rotating valve must be opened; after the welding process, it must be closed.**

- Set the required amount of shielding gas on the pressure reducer, about 4 - 15 l/min depending on the current strength and the material.

**Rule of thumb for gas flow rate:**

**Diameter of gas nozzle in mm corresponds to gas flow in l/min.**

**Example: 7 mm gas nozzle corresponds to 7 l/min gas flow**

## 5.7.2 Connecting a TIG welding torch with rotating gas valve

### 5.7.2.1 Pico 300 cel

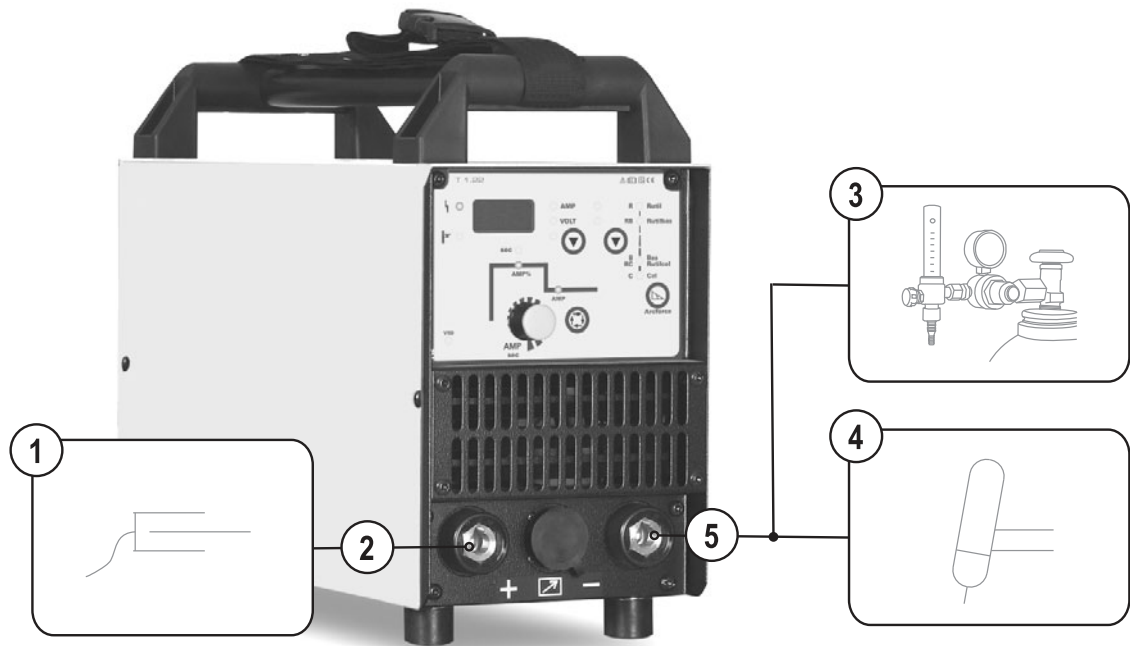

Figure 5-10

Item	Symbol	Description
1		<b>Workpiece</b>
2	+	<b>Connection socket for "+" welding current</b> Workpiece lead connection
3		<b>Output side of the pressure reducer</b>
4		<b>Welding torch</b>
5	—	<b>Connection socket, "-" welding current</b> Welding current lead connection for TIG welding torch

- Insert the welding current plug on the welding torch into the welding current connection socket and lock by turning to the right.
- Insert the cable plug on the work piece lead into the "+" welding current connection socket and lock by turning to the right.
- Screw the shielding gas connection of the welding torch to the pressure reducer on the shielding gas cylinder.

## 5.7.2.2 Pico 300 cel pws

### NOTE



For machines with pole reversal switch (PWS), the welding current polarity is changed as follows after selecting “TIG welding process”:

- Electrode holder connection socket = welding current polarity “-”,
- Workpiece lead connection socket = welding current polarity “+”.

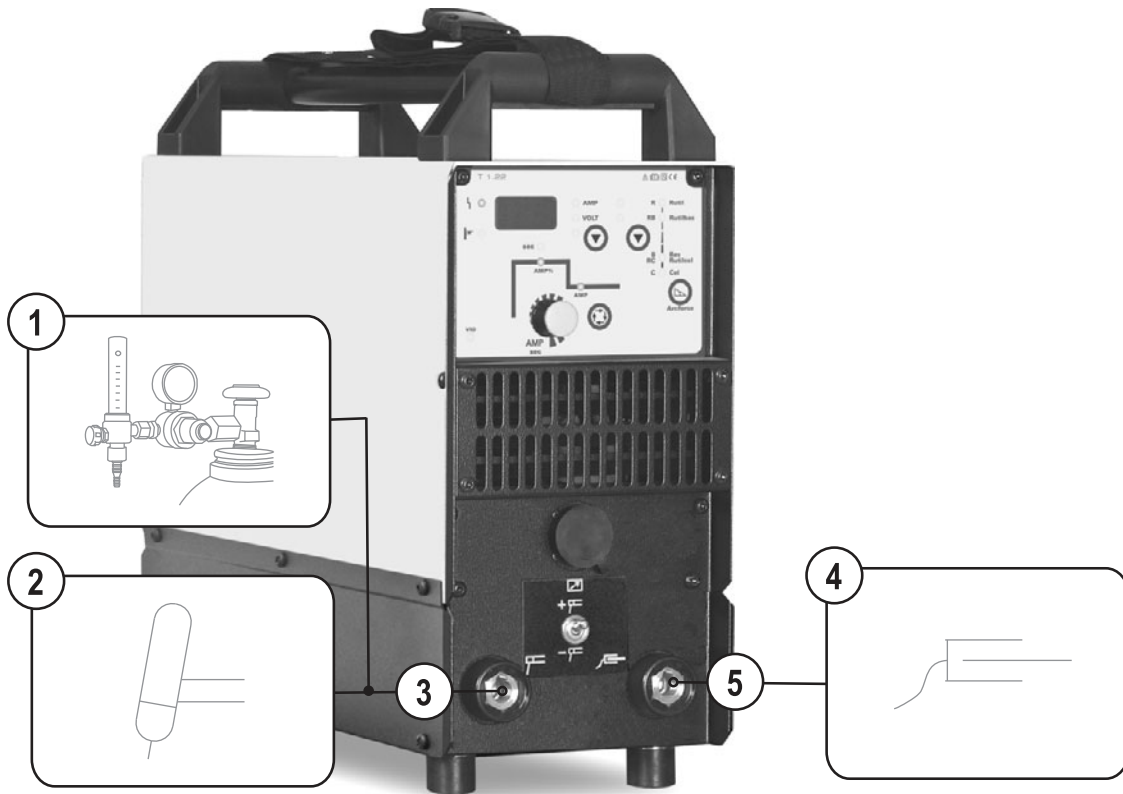







Figure 5-11

Item	Symbol	Description
1		Output side of the pressure reducer
2		Welding torch
3		Connection socket, TIG welding torch
4		Workpiece
5		Connection socket, workpiece lead

- Insert the welding current plug of the welding torch into the connection socket and lock by turning to the right.
- Insert cable plug on the workpiece lead into the welding current socket “” and lock by turning to the right.
- Screw the shielding gas connection of the welding torch to the pressure reducer on the shielding gas cylinder.



## 5.7.3 TIG welding selection

Control element	Action	Result
		TIG welding signal light  lights up
		Main current setting

## 5.7.4 TIG arc ignition

## 5.7.4.1 Liftarc ignition

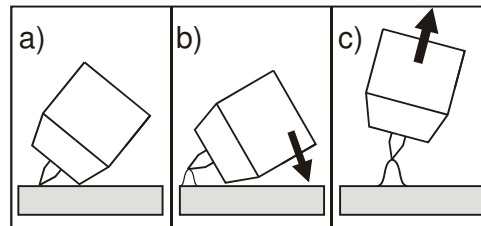

Figure 5-12

**The arc is ignited on contact with the workpiece:**

- Carefully place the torch gas nozzle and tungsten electrode tip onto the workpiece (liftarc current flowing, regardless of the main current set).
- Incline the torch towards the torch gas nozzle until there is a gap of approx. 2-3mm between the tip of the electrode and the workpiece (arc ignites, current increases to the main current set).
- Lift off the torch and swivel to the normal position.

**Ending the welding process: Remove the torch from the workpiece until the arc goes out.**

## 5.8 Advanced settings

**NOTE**

To enable the greatest possible breadth of applications, the following parameters can be adjusted or optimised for the welding task.

### 5.8.1 Arc length restriction (USP)

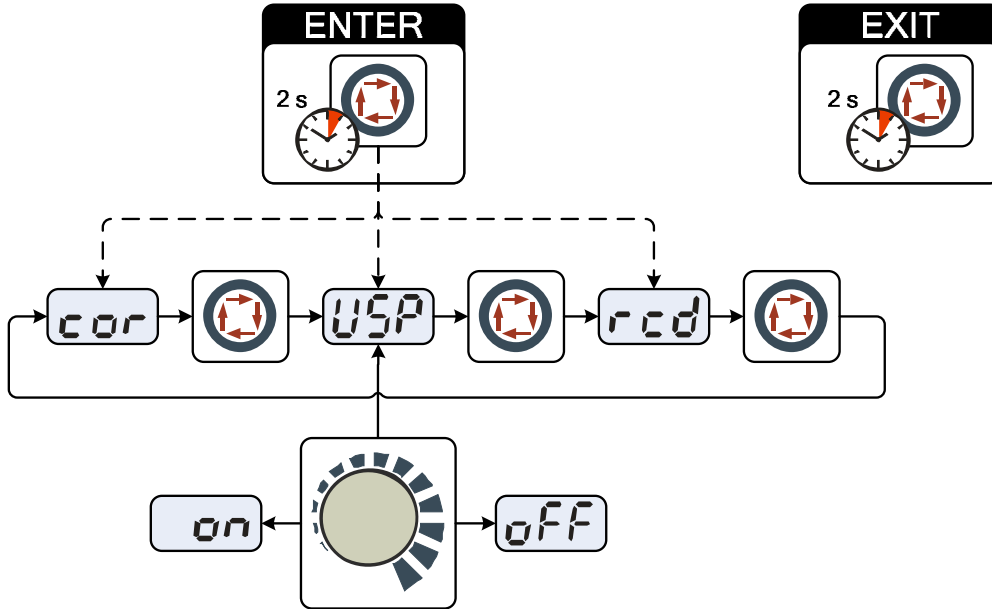

Figure 5-13

Display	Setting/selection
	<b>Arc length restriction</b> on      Function switched on (TIG, factory setting) off     Function switched off (MMA, factory setting)

## 5.8.2 Activating the welding current actual value display

The welding current can be displayed as a setpoint value or an actual value on the welding data display. The factory setting is that the welding current is displayed as a setpoint value (parameter "rcd" = off).

After switching over to the actual value display (parameter "rcd" = on), the following is displayed:

- The setpoint value is displayed in open circuit mode (when no welding current is flowing)
- If welding current is flowing, the welding data display switches over to the actual value
- After welding, the setpoint value is displayed once more

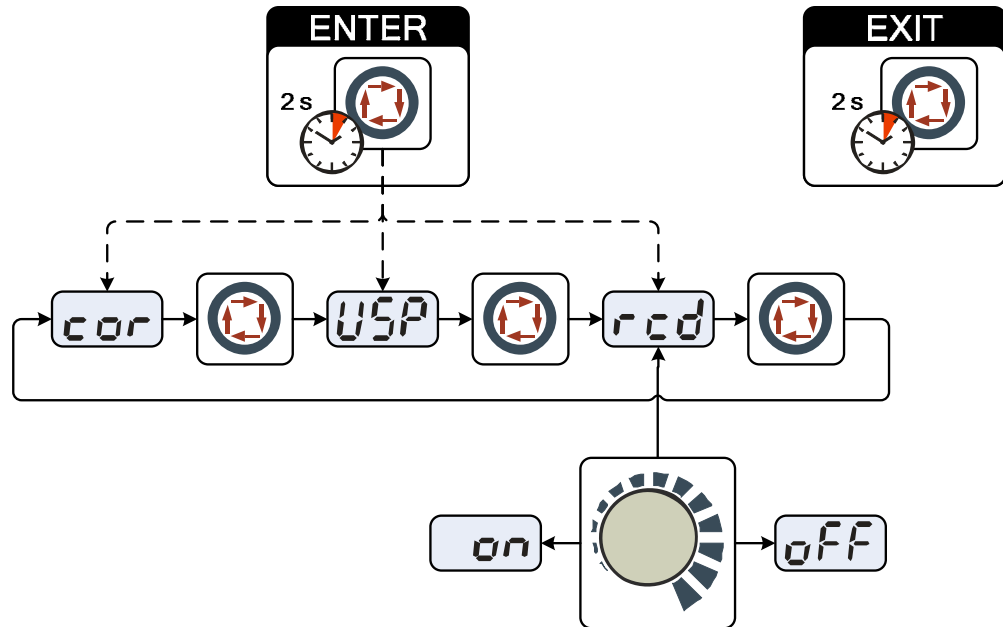

Figure 5-14

Display	Setting/selection
<code>rcd</code>	<b>Power display switching</b> on Actual value display off Setpoint value display (factory setting)

## 5.9 Voltage reducing device (VRD/SVRD)

The signal light (VRD open circuit voltage reduction) indicates when the voltage reduction device has been activated. This then ensures that the open circuit voltage between the electrode holder and the workpiece is reduced to the permissible values.

The voltage reducing device is a requirement in some countries and in many internal company safety guidelines for power sources.

A distinction is made between two versions:

- VRD (**V**oltage **R**eduction **D**evice) or
- SVRD (**S**low **V**oltage **R**eduction **D**evice)

Both switches meet the European standard (EN 60974-1:2005) and result in an increase in safety in hazardous environments in particular (such as ship construction, pipe construction, mining).

VRD reduces the open circuit voltage to 12 V within 0.2 s and thus fulfils the Australian standard (AS 1674.2-2003). SVRD reduces the open circuit voltage within 0.8 s to 12 V and thus fulfils the Russian standard (ГОСТ 12.2 007.8).

## 5.10 Remote control

### NOTE



The remote control is operated on the 19-pole remote control connection socket.

### 5.10.1 Foot-operated remote control RTF 1



#### Features

- Infinitely adjustable welding current (0% to 100%) depending on the preselected main current on the welding machine.

### 5.10.2 Manual remote control RT 1



#### Functions

- Infinitely adjustable welding current (0% to 100%) depending on the preselected main current on the welding machine.

### 5.10.3 Manual remote control RT PWS 1



#### Functions

- Infinitely adjustable welding current (0% to 100%) depending on the preselected main current at the welding machine
- Pole reversing switch, suitable for machines with PWS function

## 5.11 Dirt filter

**NOTE**

 These accessory components can be retrofitted as an option, see Accessories chapter.

The dirt filter can be used in places with unusually high levels of dirt and dust in the ambient air. The filter reduces the duty cycle of the welding machine via the reduced flow of cooling air. The filter must be disassembled and cleaned regularly depending on the level of dirt (blow out with compressed air).

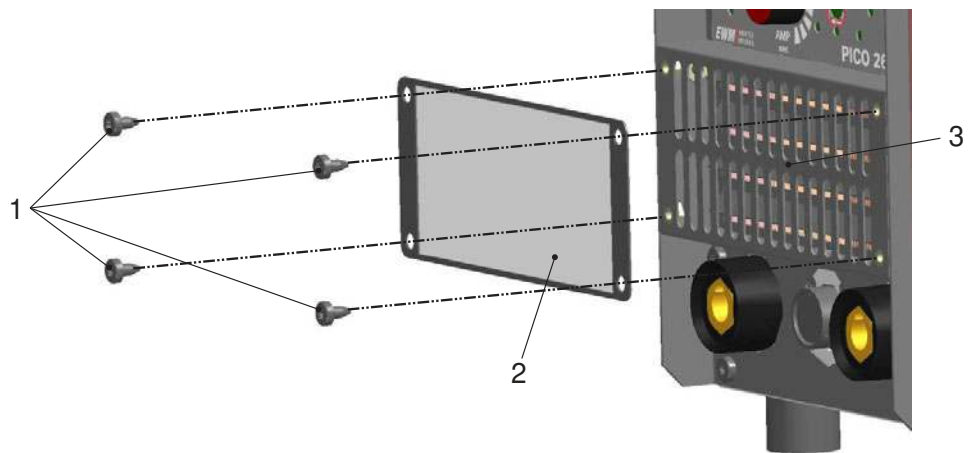

Figure 5-15

Item	Symbol	Description
1		4 fixing screws for dirt filter
2		Dirt filter with fixing plate
3		Cooling air inlet

- Fix dirt filter with 4 fixing screws on the front of the casing (cooling air inlet) of the welding machine.

## 6 Maintenance, care and disposal



### DANGER



**Risk of injury from electric shock!**

**Cleaning machines that are not disconnected from the mains can lead to serious injuries!**

- Disconnect the machine completely from the mains.
- Remove the mains plug!
- Wait for 4 minutes until the capacitors have discharged!

### 6.1 General

When used in the specified environmental conditions and under normal operating conditions, this machine is largely maintenance-free and requires a minimum of care.

There are some points, which should be observed, to guarantee fault-free operation of your welding machine. Among these are regular cleaning and checking as described below, depending on the pollution level of the environment and the length of time the unit is in use.

### 6.2 Maintenance work, intervals

#### 6.2.1 Daily maintenance tasks

- Mains supply lead and its strain relief
- Welding current cables (check that they are fitted correctly and secured)
- Gas tubes and their switching equipment (solenoid valve)
- Operating, message, safety and adjustment devices (Functional test)
- Other, general condition

#### 6.2.2 Monthly maintenance tasks

- Casing damage (front, rear and side walls)
- Transport elements (strap, lifting lugs, handle)
- Selector switches, command devices, emergency stop devices, voltage reducing devices, message and control lamps

#### 6.2.3 Annual test (inspection and testing during operation)

### NOTE



**The welding machine may only be tested by competent, capable persons!**

**A capable person is one who, because of his training, knowledge and experience, is able to recognise the dangers that can occur while testing welding power sources as well as possible subsequent damage and who is able to implement the required safety procedures.**



**For further information, please see the accompanying supplementary sheets "Machine and Company Data, Maintenance and Testing, Warranty"!**

The former term of repetition test has been replaced due to a change in the corresponding standard with "Inspection and testing during operation".

In addition to the regulations on the test given here, the relevant local laws and regulations must also be observed.

## 6.3 Repair Work

### DANGER



**Do not carry out any unauthorised repairs or modifications!**

**To avoid injury and equipment damage, the unit must only be repaired or modified by specialist, skilled persons!**

**The warranty becomes null and void in the event of unauthorised interference.**

- Appoint only skilled persons for repair work (trained service personnel)!

Repair and maintenance work may only be performed by qualified authorised personnel; otherwise the right to claim under warranty is void. In all service matters, always consult the dealer who supplied the machine. Return deliveries of defective equipment subject to warranty may only be made through your dealer. When replacing parts, use only original spare parts. When ordering spare parts, please quote the machine type, serial number and item number of the machine, as well as the type designation and item number of the spare part.

## 6.4 Disposing of equipment

### NOTE



**Proper disposal!**

**The machine contains valuable raw materials, which should be recycled, and electronic components, which must be disposed of.**

- Do not dispose of in household waste!
- Observe the local regulations regarding disposal!



### 6.4.1 Manufacturer's declaration to the end user

- According to European provisions (guideline 2002/96/EG of the European Parliament and the Council of January, 27th 2003), used electric and electronic equipment may no longer be placed in unsorted municipal waste. It must be collected separately. The symbol depicting a waste container on wheels indicates that the equipment must be collected separately. This machine is to be placed for disposal or recycling in the waste separation systems provided for this purpose.
- According to German law (law governing the distribution, taking back and environmentally correct disposal of electric and electronic equipment (ElektroG) from 16.03.2005), used machines are to be placed in a collection system separate from unsorted municipal waste. The public waste management utilities (communities) have created collection points at which used equipment from private households can be disposed of free of charge.
- Information about giving back used equipment or about collections can be obtained from the respective municipal administration office.
- EWM participates in an approved waste disposal and recycling system and is registered in the Used Electrical Equipment Register (EAR) under number WEEE DE 57686922.
- In addition to this, returns are also possible throughout Europe via EWM sales partners.

## 6.5 Meeting the requirements of RoHS

We, EWM HIGHTEC Welding GmbH Mündersbach, hereby confirm that all products supplied by us which are affected by the RoHS Directive, meet the requirements of the RoHS (Directive 2002/95/EC).

## 7 Rectifying faults

All products are subject to rigorous production checks and final checks. If, despite this, something fails to work at any time, please check the product using the following flowchart. If none of the fault rectification procedures described leads to the correct functioning of the product, please inform your authorised dealer.

### 7.1 Error messages (power source)

#### NOTE



**A welding machine error is indicated by the collective fault signal lamp (A1) lighting up and an error code (see table) being displayed in the machine control display. In the event of a machine error, the power unit shuts down.**

- If multiple errors occur, these are displayed in succession.
- Document machine errors and inform service staff as necessary.

Error message	Possible cause	Remedy
"E 1"	Electronics error	Switch the machine off and back on again. If the error persists, inform the service dept.
"E 2"	Temperature error	Allow machine to cool down.
"E 3"	Electronics error	See "E 1".
"E 4"	Electronics error	See "E 1".
"E 5"	Electronics error	See "E 1".
"E 6"	Balancing error in voltage recording	Switch off the machine, place the electrode holder in an insulated position and switch the machine back on. If the error persists, inform the service dept.
"E 7"	Balancing error in current recording	
"E 8"	Error in one of the electronics supply voltages	Switch the machine off and back on again. If the error persists, inform the service dept.
"E 9"	Mains undervoltage	Switch off the machine and check the mains voltage.
"E10"	Secondary excess voltage	Switch the machine off and back on again. If the error persists, inform the service dept.
"E11"	Mains excess voltage	Switch off the machine and check the mains voltage.
"E12"	Voltage reduction error (VRD)	Switch the machine off and back on again. If the error persists, inform the service dept.



## 7.2 Resetting welding parameters to the factory settings

**NOTE**

All customised welding parameters that are stored will be replaced by the factory settings.

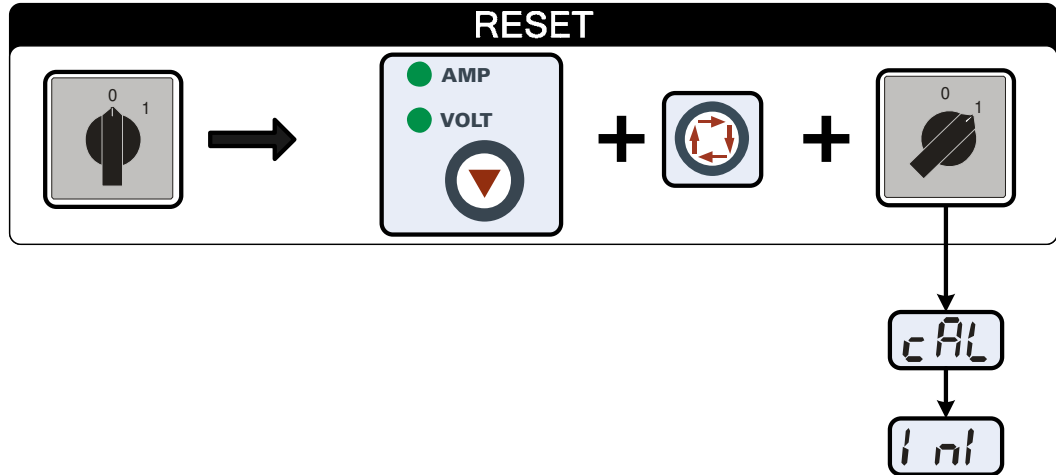

Figure 7-1

Display	Setting/selection
	<b>Calibration</b> The machine will be calibrated for approx 2 seconds each time it is switched on.
	<b>Initialising</b> All customised welding parameters that are stored will be replaced by the factory settings.

## 8 Technical data

### 8.1 Pico 300 cel

#### NOTE



**Performance specifications and guarantee only in connection with original spare and replacement parts!**

	MMA	TIG
Current setting range	10 A-300 A	5 A-300 A
Voltage setting range	20.4 V-32.0 V	10.4 V-22.0 V
Duty cycle at 25 °C		
30%	300 A	-
40%	-	300 A
60%	250 A	260 A
100%	190 A	200 A
Duty cycle at 40 °C		
25%	300 A	-
30%	-	300 A
60%	220 A	240 A
100%	170 A	190 A
Load alternation	10 min. (60% DC ^ 6 min. welding, 4 min. pause)	
Open circuit voltage	99 V	
Open circuit voltage (VRD)	12 V	
Open circuit voltage (SVRD)	12 V	
Mains voltage (tolerances)	3 x 400 V (+20% to -25%)	
Frequency	50/60 Hz	
Mains fuse (safety fuse, slow-blow)	16 A	
Mains connection lead	H07RN-F4G1,5	
Max. connected load	12.1 kVA	8.3 kVA
Recommended generator rating	16.4 kVA	
cosφ at I <sub>max</sub>	0.99	
Insulation class/protection classification	H/IP 23	
Ambient temperature	-20 °C to +40 °C	
Machine cooling/torch cooling	Fan/gas	
Workpiece lead	35 mm <sup>2</sup>	
Dimensions L/W/H	515 x 185 x 350 mm	
Dimensions L/W/H (pws)	515 x 185 x 445 mm	
Weight	16.5 kg	
Weight (pws)	23.5 kg	
Constructed to standards	IEC 60974-1, -10 [S] / C E	

## 9 Accessories, options

### 9.1 Welding torch, electrode holder and workpiece lead

Type	Designation	Item no.
EH50 4M	Electrode holder	092-000004-00000
WK50QMM 4M KL	Workpiece cable, clamp	092-000003-00000
TIG 26V 4M	ABITIG 26 V 4 m BCC-1 BHC-01	094-010979-00000

### 9.2 Remote controls and accessories

Type	Designation	Item no.
RT1	Remote control current	090-008097-00000
RA5 19POL 5M	Remote control e.g. connection cable	092-001470-00005
RA10 19POL 10M	Remote control e.g. connection cable	092-001470-00010
RA20 19POL 20M	Remote control e.g. connection cable	092-001470-00020
RTF1 19POLE 5M	Foot-operated remote control current with connection cable	094-006680-00000
RV5M19 19POLE 5M	Extension cable	092-000857-00000

#### 9.2.1 Pico 300 cel pws

Type	Designation	Item no.
RT PWS1	Remote control vertical-down current, pole reversal	090-008199-00000

### 9.3 Options

Type	Designation	Item no.
ON FILTER	Retrofit option, contamination filter for air inlet	092-001856-00000

### 9.4 General accessories

Type	Designation	Item no.
DM1 32L/MIN	Manometer pressure reducer	094-000009-00000
5POLE/CEE/16A/M	Machine plug	094-000712-00000

## 10 Appendix A

### 10.1 Overview of EWM branches

[www.ewm-group.com](http://www.ewm-group.com)

[www.ewm-tx.de](http://www.ewm-tx.de)

#### **EWM HIGHTEC WELDING GmbH**

Dr. Günter-Henle-Straße 8  
56271 Mündersbach  
Deutschland  
Tel: +49 2680 181-0 · Fax: -244  
[www.ewm-group.com](http://www.ewm-group.com) · [info@ewm-group.com](mailto:info@ewm-group.com)

#### **EWM SCHWEISSTECHNIK-HANDELS-GMBH**

In der Florinskaul 14-16  
56218 Mülheim-Kärlich · Deutschland  
Tel: +49 261 988898-0 · Fax: -244  
[www.ewm-group.com/handel](http://www.ewm-group.com/handel) · [nl-muelheim@ewm-group.com](mailto:nl-muelheim@ewm-group.com)

#### **EWM SCHWEISSTECHNIK-HANDELS-GMBH**

Sachsstraße 28  
50259 Pulheim · Deutschland  
Tel: +49 2234 697-047 · Fax: -048  
[www.ewm-group.com/handel](http://www.ewm-group.com/handel) · [nl-koeln@ewm-group.com](mailto:nl-koeln@ewm-group.com)

#### **EWM HIGHTEC WELDING GmbH**

Niederlassung Nord  
Lindenstraße 1a  
38723 Seesen-Rhüden · Deutschland  
Tel: +49 5384 90798-0 · Fax: -20  
[www.ewm-group.com/handel](http://www.ewm-group.com/handel) · [nl-nord@ewm-group.com](mailto:nl-nord@ewm-group.com)

#### **EWM HIGHTEC WELDING s.r.o.**

Tr. 9. května 718  
407 53 Jiřkov · Tschechische Republik  
Tel: +420 412 358-551 · Fax: -20  
[www.ewm-group.com/cz](http://www.ewm-group.com/cz) · [info.cz@ewm-group.com](mailto:info.cz@ewm-group.com)

#### **EWM HIGHTEC WELDING SALES s.r.o.**

Prodejní a poradenské centrum  
Tyršova 2106  
256 01 Benešov u Prahy · Tschechische Republik  
Tel: +420 317 729-517 · Fax: -712  
[www.ewm-group.com/cz](http://www.ewm-group.com/cz) · [sales.cz@ewm-group.com](mailto:sales.cz@ewm-group.com)

#### **EWM HIGHTEC WELDING UK Ltd.**

Unit 2B Coopies Way  
Coopies Lane Industrial Estate  
Morpeth · Northumberland · NE 61 6JN · Großbritannien  
Tel: +44 1670 505875 · Fax: -514305  
[www.ewm-group.com/uk](http://www.ewm-group.com/uk) · [info.uk@ewm-group.com](mailto:info.uk@ewm-group.com)

#### **EWM HIGHTEC WELDING GmbH**

Scharnsteinerstraße 15  
4810 Gmunden · Österreich  
Tel: +43 7612 778 02-0 · Fax: -20  
[www.ewm-group.com/at](http://www.ewm-group.com/at) · [info.at@ewm-group.com](mailto:info.at@ewm-group.com)

#### **EWM HIGHTEC WELDING (Kunshan) Ltd.**

10 Yuanshan Road, Kunshan  
New & High-tech Industry Development Zone  
Kunshan · Jiangsu · 215300 · Volksrepublik China  
Tel: +86 512 57867-188 · Fax: -182  
[www.ewm-group.com/cn](http://www.ewm-group.com/cn) · [info.cn@ewm-group.com](mailto:info.cn@ewm-group.com)

#### **EWM HIGHTEC WELDING FZCO**

Regional Office Middle East  
JAFZA View 18 F 14 05 · PO. Box 262851  
Jebel Ali Free Zone · Dubai · Vereinigte Arabische Emirate  
Tel: +971 4 8857-789 · Fax: -500  
[www.ewm-group.com/me](http://www.ewm-group.com/me) · [info.me@ewm-group.com](mailto:info.me@ewm-group.com)